

SuperZoom-44 Quick Guide



Default IP, Username and Password

- Default IP address: 192.168.1.13 or 192.168.0.13 (vary with firmware version)
- Default username: admin
- Default password: 123456

The default password is used for your first login. To ensure account security, please change the password after your first login. You are recommended to set a strong password (no less than eight characters).

Appearance

Dimensions

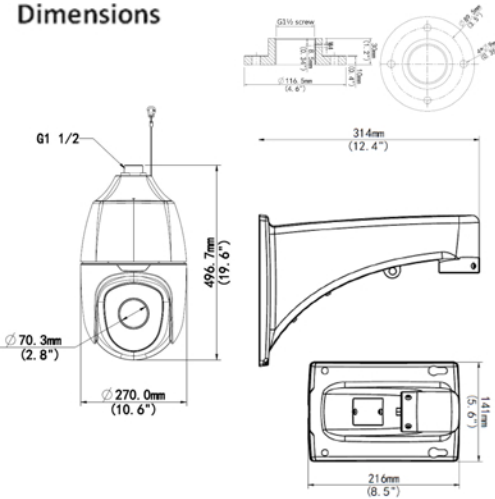

Cable Connection

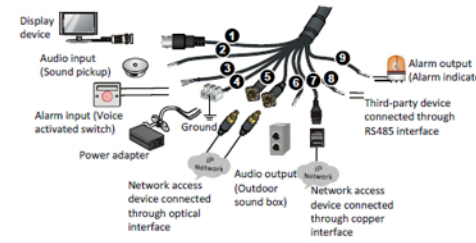

No.	Interface	Function
1	VIDEO OUT	Video output interface. Output video signals and connect to analog devices such as monitors for video display.
2	AUDIO IN	Audio input interface. Input audio signals or performs intercom. Note: Audio input and intercom cannot be used at the same time with this interface.
3	ALARM IN	Alarm input interface. Input alarm signals.
4	Power interface	Connect to the power adaptor.
5	Optical interface	100M/1000M Base-FX adaptive SFP module. Connect to the optical network. Note: The optical is single mode fiber. See Optical fiber for more information.
6	AUDIO OUT	Audio output interface. Output audio signals.
7	Ethernet interface	10M/100M Base-TX adaptive Ethernet interface. Connect to the network.
8	RS485	Serial port. Interact and control an external device. For example, it can control a third-party device.
9	ALARM OUT	Alarm output interface. Output alarm signals.

Waterproof Components for an RJ45 Plug

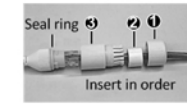

Attach the seal ring to the Ethernet interface. Mount the waterproof components in order. Then insert the cable into the Ethernet interface and screw the waterproof bolt in.

Waterproof Tail Cable

Connect the tail cables and then take the following steps to protect the tail cables from water using waterproof tapes. The figures are for your reference only.



1. Connect the tail cables, and protect the cables and cable connections using insulating tapes. Then wrap all the tail cables together using insulating tapes.



2. Choose a start point for waterproof tapes and protect the tail cables using waterproof tapes.

You can crimp the inner wires of the cable with the RJ45 plug first and then cover the waterproof components. You may also cover the waterproof components first.

Coax Seal Recommended

Access Your Camera

Before you begin, check that:

- Your camera is operating properly and connected to the network.
- The PC you are using is installed with Internet Explorer 7.0 or later.

Follow these steps to access your camera through the Web interface:

1. Open your browser, input the IP address of your camera in the address bar and then press **Enter** to open the login page.
2. Enter the username and password and then click **Login**.

Part # - EC-PTZIR-44x
3 year warranty



866-264-0041

sales@envirocams.com
201 N. Elm St.
Kemp, TX 75143

Not Your Father's IP Cameras

8. Secure the dome with two M5 screws.



9. Connect the cables and attach the bracket to the wall with flat pads, washers and nuts.

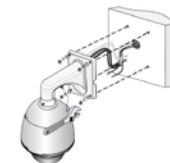

5. Secure the bracket adapter with a screw.



6. Attach the safety wire to the bracket and the dome. And Lead the tail cable through the bracket.



7. Attach the dome to the bracket adapter.

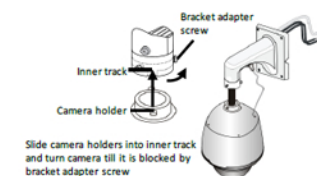

Slide camera holders into inner track and turn camera till it is blocked by bracket adapter screw

Wall Mount Your Camera

1. Position the drill holes and mark according to the bracket, and then lead the cables out of the wall.

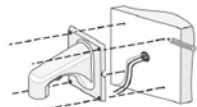

2. Drill holes on the wall. Use a drill bit that matches the diameter of plastic anchor, and refer to bolt length for hole depth.

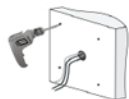

3. Knock in the expansion bolts and ensure that they are locked into place.



4. Turn the bracket adapter (G1 1/2 male thread) in.



Bracket adapter