

DIP Manual ⁽¹²⁸⁾

Connecting diagram

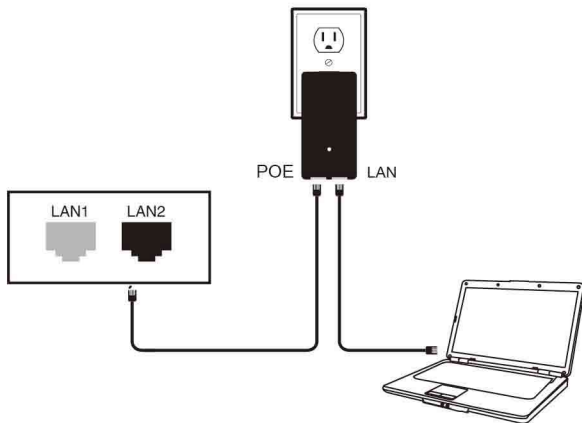

POE Port connect with any port of AP

POE LAN port connect with PC(Switch or NVR)

NOTE: 1.Both RJ45 ports(black and yellow) on AP are LAN connections.

2.If you want to enter web page, you need manually bound IP address of PC

3.The PoE power adapter has 3 inputs. One is for the AC cord, and two are for networking.

4.Please note the PoE adapter and power cord are not designed for outdoor use and should be used indoors only.

Connecting diagram PoE Power

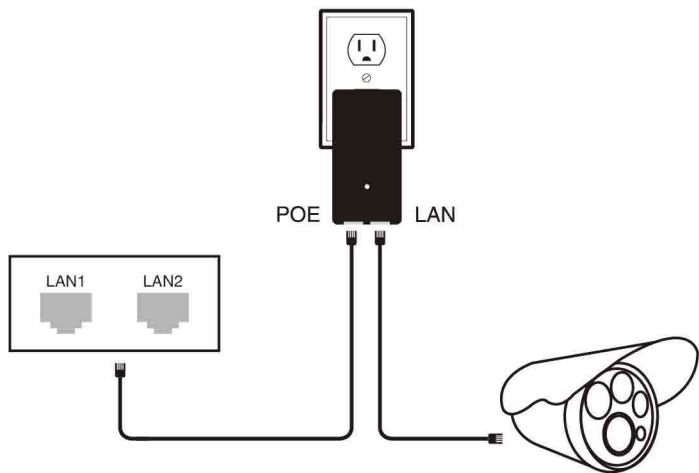

The bottom of the adapter has two RJ45 connections. One marked POE and one marked LAN.

Using one CAT5 cable(Network cable) , connect one end to "LAN" and the other end to your camera,recorder, PC, etc.

Connecting diagram DC Power

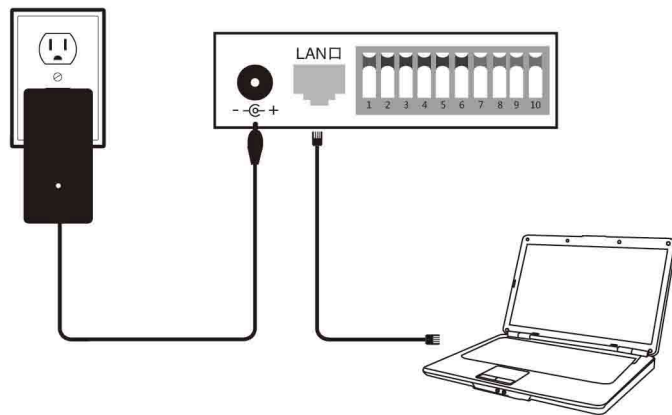

DC Power -----> Connect with DC Port

LAN Port -----> Connect with PC(Switch or NVR)

NOTE: If you want to enter web page, you need to bind IP address of PC

Connecting diagram DC Power

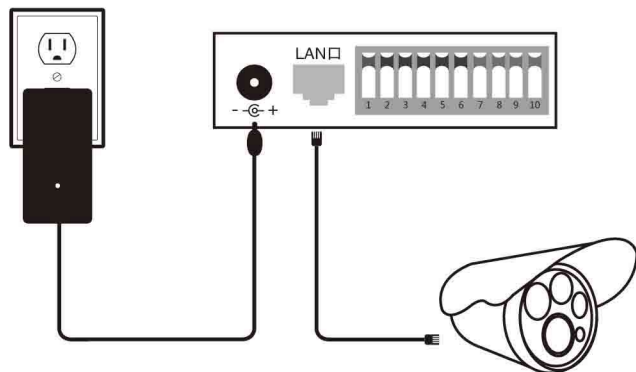

DC Power -----> Connect with DC Port

LAN Port -----> Connect with camera

DIP device instructions

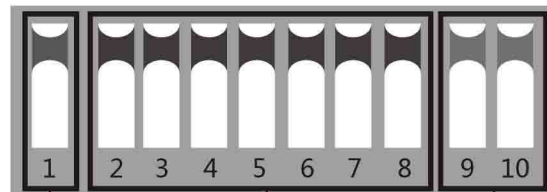

Working Mode Key

Matching Key

IP Key

Button 1 changes the mode of the device. UP is access point (AP) mode for use with your recorder, PC, etc.. DOWN is for use with your camera.

Button 2 through 8 are for matching AP devices together. There are 128 various combinations that can be made from the 7 keys, which corresponds to 128 different SSIDs and 128 different segments. The Pages 8-15 below shows all possible combinations.

Button 9 & 10 are for point to multi-point functionality. To use up to 4 cameras with one recorder, configure the DIP switches as follows:

1. On the recorder/PC/Switch side, switches 9 and 10 should remain up.
2. On the camera side, select one of 4 configurations for switches 9 and 10:
 - a. Camera 1: 9 Down and 10 Down
 - b. Camera 2: 9 Down and 10 Up
 - c. Camera 3: 9 Up and 10 Down
 - d. Camera 4: 9 Up and 10 Up

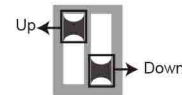

3. You cannot duplicate the switch settings between Cameras for switches 9 & 10 or you will experience interference, thus the max of 4 points.

Remarks:

1. Turn off the AP power before setting the button.
2. The SSID of DIP type AP defaults is not broadcast, password has been set up and can be customized.
3. Make sure the IP address of the camera is different from AP

The specific operation for setting management

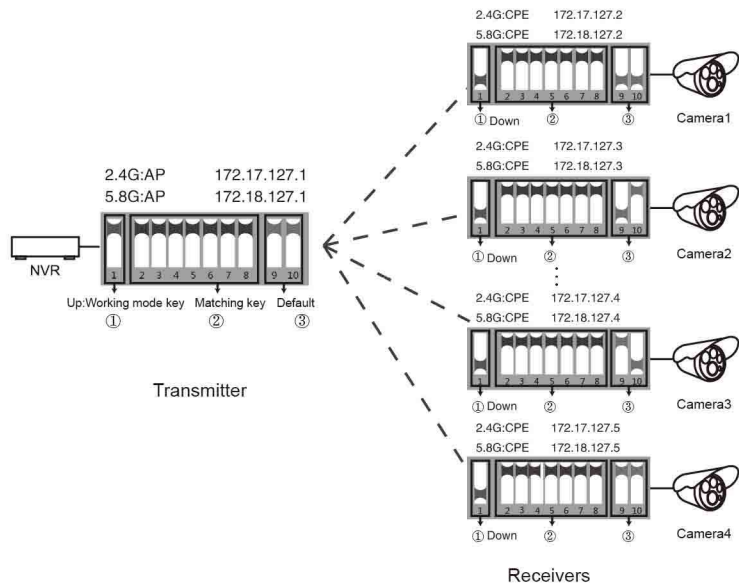

NOTE: For the point-to-point case, either of the four camera options above is available. Make sure the working mode key and matching Key are set right.

Signal power setting

Step 1 Set the static IP address as below

The screenshot shows the 'General' network settings page. The 'Obtain an IP address automatically' option is unselected, and 'Use the following IP address:' is selected. The IP address is set to 172.18.128.1, the Subnet mask is 255.255.0.0, and the Default gateway is The 'Obtain DNS server address automatically' option is also unselected, and 'Use the following DNS server address:' is selected. The Preferred DNS server and Alternate DNS server fields are empty. There are 'Advanced...', 'OK', and 'Cancel' buttons at the bottom.

NOTE: Subnet Mask must be "255.255.0.0" for IP "172.18.128.1"

(picture 1)

NOTE: The bound IP address of 2.4G is 172.17.128.1
 Subnet mask is 255.255.0.0
 The bound IP address of 5.8G is 172.18.128.1
 Subnet mask is 255.255.0.0

Signal power setting

Step 2 Type the IP address of corresponding AP device in IE browser to get into the WEP page, the default password is “password”. Signal power can be set after logging.

Wireless Network

Status	Transmit Power Configuration Power: <input type="text" value="27"/> dBm(Max 27 dBm)
System	Encryption Configuration Use Custom Key: <input type="checkbox"/> <input type="text" value="....."/> <input type="checkbox"/> show
> Transmit Power Mode	Distance Configuration Distance: <input type="text" value="2KM"/> ▼
Router Access	Client Signal Threshold Signal Threshold: <input type="text" value="Close"/> ▼ (Only for Station)
Time	<input type="button" value="Save Changes >"/> <input type="button" value="Reset >"/>
Backup / Restore	
Update Firmware	
Reboot	
Logout	

Transmit Power Configuration: The default is the maximum value, the transmit power should be reduced appropriately when the signal is too strong.

Encryption Configuration: Customized key can be used for security. (The same key should be set in the transmitter and receiver.)

Distance Configuration: Default value is two kilometers, it should be set according to practical situation. (The same distance value should be set in the transmitter and receiver. If not, it will lead to high latency, low bandwidth network connection.)

Q&A

Q1: What should be noted when setting the AP button?

A1: Make sure the power is off.

Q2: How dose the AP work without power supply?

A2: The AP gets the power via the cable. It is called POE. Two cables are needed for the connection. STP CAT5e cable is strongly recommended for this case.

Q3: How long the POE cable can be?

A3: The length of the cable depends on the power voltage and cable quality. For 24V power, the length of the cable can be 40 meters, while 10-20 meters for 12V power.

Q4: Why the signal light does not work after switching the button?

A4: Please turn off the AP power first. It is recommended to do the troubleshooting test as below. For the transmitter, keep the button from “1” to “10” UP. For the receiver, keep the button “1” DOWN, and the button from “2” to “10” UP. After finishing, turn on the power and wait for three minutes. The distance between the transmitter and the receiver should be more than 2 meters.



Q5: Why the local network connection is choppy after the AP installation?

A5: Shoot the trouble with below methods:

1. Change the cable to see if it is a cable problem
2. Change the wireless channel to avoid the signal interference.

Q6: Can the 10-digit AP be compatible with the previous 8-digit ones?

A6: Sure. Log in the WEP page, select "system" menu, click "mode", check the box of "8-digit DIP Switch mode", then "Save Changes". Turn off the AP power. And then set up the AP according to the operation of 8-DIP device (only focusing on 1-8 buttons)

Q7: How to log in the WEP page?

A7: Set the computer with static IP address as shown in Page 6-7, and type the IP address of the corresponding device in IE browser.

Q8: After the connection of the AP and NVR, why the IP address of the camera can be found but no video available on the monitor?

A8: Connect the adapter which links to the NVR with the yellow LAN port of the AP.

Q9: The status of signal light

A9: Red: PWR: The power light. It will work when power is on.

Blue: WLAN: WIFI signal light. It will strobe when working.

LAN1, LAN2: The LAN1/LAN2 light. It will be on when working.

Orange: Wireless signal light from 1st - 4th

1st light on: the signal is too weak.

1st , 2nd lights on: signal is weak.

1st, 2nd, 3rd lights on: the signal is regular.

ONLY the 4th light on: the signal is too strong.

If four lights are on, the signal is in the best condition

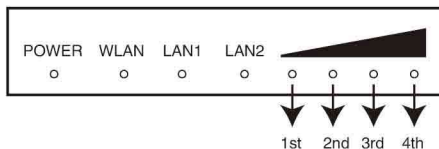

































Q10: How to reset the device?















A10: Long press the RST button for 6 seconds in the state of power-on.















128 pair DIP codes, segment and frequency can be referred to the following chart:

















Group	2-8 Dial	IP segment	5.8GHz	IP segment	2.4GHz
No.1		172.18.0.X	4960	172.17.0.X	2332
No.2		172.18.1.X	4980	172.17.1.X	2337
No.3		172.18.2.X	5000	172.17.2.X	2342
No.4		172.18.3.X	5020	172.17.3.X	2347
No.5		172.18.4.X	5040	172.17.4.X	2352
No.6		172.18.5.X	5060	172.17.5.X	2357
No.7		172.18.6.X	5080	172.17.6.X	2362
No.8		172.18.7.X	5100	172.17.7.X	2367
No.9		172.18.8.X	5120	172.17.8.X	2372
No.10		172.18.9.X	5140	172.17.9.X	2377
No.11		172.18.10.X	5160	172.17.10.X	2382
No.12		172.18.11.X	5180	172.17.11.X	2387
No.13		172.18.12.X	5200	172.17.12.X	2392
No.14		172.18.13.X	5220	172.17.13.X	2397
No.15		172.18.14.X	5240	172.17.14.X	2402
No.16		172.18.15.X	5745	172.17.15.X	2412

















Group	2-8 Dial	IP segment	5.8GHz	IP segment	2.4GHz
No.17		172.18.16.X	5765	172.17.16.X	2417
No.18		172.18.17.X	5785	172.17.17.X	2422
No.19		172.18.18.X	5805	172.17.18.X	2427
No.20		172.18.19.X	5825	172.17.19.X	2432
No.21		172.18.20.X	5845	172.17.20.X	2437
No.22		172.18.21.X	5865	172.17.21.X	2442
No.23		172.18.22.X	5885	172.17.22.X	2447
No.24		172.18.23.X	5905	172.17.23.X	2452
No.25		172.18.24.X	5925	172.17.24.X	2457
No.26		172.18.25.X	5945	172.17.25.X	2462
No.27		172.18.26.X	5965	172.17.26.X	2467
No.28		172.18.27.X	5985	172.17.27.X	2472
No.29		172.18.28.X	6005	172.17.28.X	2492
No.30		172.18.29.X	6025	172.17.29.X	2512
No.31		172.18.30.X	6045	172.17.30.X	2532
No.32		172.18.31.X	6065	172.17.31.X	2552

















Group	2-8 Dial	IP segment	5.8GHz	IP segment	2.4GHz
No.33		172.18.32.X	4960	172.17.32.X	2572
No.34		172.18.33.X	4980	172.17.33.X	2592
No.35		172.18.34.X	5000	172.17.34.X	2612
No.36		172.18.35.X	5020	172.17.35.X	2632
No.37		172.18.36.X	5040	172.17.36.X	2652
No.38		172.18.37.X	5060	172.17.37.X	2672
No.39		172.18.38.X	5080	172.17.38.X	2692
No.40		172.18.39.X	5100	172.17.39.X	2712
No.41		172.18.40.X	5120	172.17.40.X	2732
No.42		172.18.41.X	5140	172.17.41.X	2332
No.43		172.18.42.X	5160	172.17.42.X	2337
No.44		172.18.43.X	5180	172.17.43.X	2342
No.45		172.18.44.X	5200	172.17.44.X	2347
No.46		172.18.45.X	5220	172.17.45.X	2352
No.47		172.18.46.X	5240	172.17.46.X	2357
No.48		172.18.47.X	5745	172.17.47.X	2362

Group	2-8 Dial	IP segment	5.8GHz	IP segment	2.4GHz
No.49		172.18.48.X	5765	172.17.48.X	2367
No.50		172.18.49.X	5785	172.17.49.X	2372
No.51		172.18.50.X	5805	172.17.50.X	2377
No.52		172.18.51.X	5825	172.17.51.X	2382
No.53		172.18.52.X	5845	172.17.52.X	2387
No.54		172.18.53.X	5865	172.17.53.X	2392
No.55		172.18.54.X	5885	172.17.54.X	2397
No.56		172.18.55.X	5905	172.17.55.X	2402
No.57		172.18.56.X	5925	172.17.56.X	2412
No.58		172.18.57.X	5945	172.17.57.X	2417
No.59		172.18.58.X	5965	172.17.58.X	2422
No.60		172.18.59.X	5985	172.17.59.X	2427
No.61		172.18.60.X	6005	172.17.60.X	2432
No.62		172.18.61.X	6025	172.17.61.X	2437
No.63		172.18.62.X	6045	172.17.62.X	2442
No.64		172.18.63.X	6065	172.17.63.X	2447

Group	2-8 Dial	IP segment	5.8GHz	IP segment	2.4GHz
No.65		172.18.64.X	4960	172.17.64.X	2452
No.66		172.18.65.X	4980	172.17.65.X	2457
No.67		172.18.66.X	5000	172.17.66.X	2462
No.68		172.18.67.X	5020	172.17.67.X	2467
No.69		172.18.68.X	5040	172.17.68.X	2472
No.70		172.18.69.X	5060	172.17.69.X	2492
No.71		172.18.70.X	5080	172.17.70.X	2512
No.72		172.18.71.X	5100	172.17.71.X	2532
No.73		172.18.72.X	5120	172.17.72.X	2552
No.74		172.18.73.X	5140	172.17.73.X	2572
No.75		172.18.74.X	5160	172.17.74.X	2592
No.76		172.18.75.X	5180	172.17.75.X	2612
No.77		172.18.76.X	5200	172.17.76.X	2632
No.78		172.18.77.X	5220	172.17.77.X	2652
No.79		172.18.78.X	5240	172.17.78.X	2672
No.80		172.18.79.X	5745	172.17.79.X	2692

Group	2-8 Dial	IP segment	5.8GHz	IP segment	2.4GHz
No.81		172.18.80.X	5765	172.17.80.X	2712
No.82		172.18.81.X	5785	172.17.81.X	2732
No.83		172.18.82.X	5805	172.17.82.X	2332
No.84		172.18.83.X	5825	172.17.83.X	2337
No.85		172.18.84.X	5845	172.17.84.X	2342
No.86		172.18.85.X	5865	172.17.85.X	2347
No.87		172.18.86.X	5885	172.17.86.X	2352
No.88		172.18.87.X	5905	172.17.87.X	2357
No.89		172.18.88.X	5925	172.17.88.X	2362
No.90		172.18.89.X	5945	172.17.89.X	2367
No.91		172.18.90.X	5965	172.17.90.X	2372
No.92		172.18.91.X	5985	172.17.91.X	2377
No.93		172.18.92.X	6005	172.17.92.X	2382
No.94		172.18.93.X	6025	172.17.93.X	2387
No.95		172.18.94.X	6045	172.17.94.X	2392
No.96		172.18.95.X	6065	172.17.95.X	2397

Group	2-8 Dial	IP segment	5.8GHz	IP segment	2.4GHz
No.97		172.18.96.X	4960	172.17.96.X	2402
No.98		172.18.97.X	4980	172.17.97.X	2412
No.99		172.18.98.X	5000	172.17.98.X	2417
No.100		172.18.99.X	5020	172.17.99.X	2422
No.101		172.18.100.X	5040	172.17.100.X	2427
No.102		172.18.101.X	5060	172.17.101.X	2432
No.103		172.18.102.X	5080	172.17.102.X	2437
No.104		172.18.103.X	5100	172.17.103.X	2442
No.105		172.18.104.X	5120	172.17.104.X	2447
No.106		172.18.105.X	5140	172.17.105.X	2452
No.107		172.18.106.X	5160	172.17.106.X	2457
No.108		172.18.107.X	5180	172.17.107.X	2462
No.109		172.18.108.X	5200	172.17.108.X	2467
No.110		172.18.109.X	5220	172.17.109.X	2472
No.111		172.18.110.X	5240	172.17.110.X	2492
No.112		172.18.111.X	5745	172.17.111.X	2512

Group	2-8 Dial	IP segment	5.8GHz	IP segment	2.4GHz
No.113		172.18.112.X	5765	172.17.112.X	2532
No.114		172.18.113.X	5785	172.17.113.X	2552
No.115		172.18.114.X	5805	172.17.114.X	2572
No.116		172.18.115.X	5825	172.17.115.X	2592
No.117		172.18.116.X	5845	172.17.116.X	2612
No.118		172.18.117.X	5865	172.17.117.X	2632
No.119		172.18.118.X	5885	172.17.118.X	2652
No.120		172.18.119.X	5905	172.17.119.X	2972
No.121		172.18.120.X	5825	172.17.120.X	2692
No.122		172.18.121.X	5945	172.17.121.X	2712
No.123		172.18.122.X	5965	172.17.122.X	2732
No.124		172.18.123.X	5985	172.17.123.X	2332
No.125		172.18.124.X	6005	172.17.124.X	2337
No.126		172.18.125.X	6025	172.17.125.X	2342
No.127		172.18.126.X	6045	172.17.126.X	2347
No.128		172.18.127.X	6065	172.17.127.X	2352